

HONEYWELL

PRU7070/7071 &
PRU7075/7076
PRINTERS
HANDBOOK

HARDWARE

PRU7070/7071 & PRU7075/7076 Printers Handbook

SUBJECT

Description and Operation of the PRU7070/7071 and the PRU7075/7076 Printers

SPECIAL INSTRUCTIONS

This manual supersedes CY93-00, dated August 1982. Change bars in the margins indicate new or changed information.

The following notice is provided in accordance with the United States Federal Communications Commission's (FCC) regulations.

Warning: This equipment generates, uses, and can radiate radio frequency energy and if not installed and used in accordance with the instructions manual, may cause interference to radio communications. It has been tested and found to comply with the limits for a Class A computing device pursuant to Subpart J of Part 15 of FCC Rules, which are designed to provide reasonable protection against such interference when operated in a commercial environment. Operation of this equipment in a residential area is likely to cause interference in which case the user at his own expense will be required to take whatever measures may be required to correct the interference.

This equipment is subject to and will comply with the appropriate FCC Rules prior to final delivery.

ORDER NUMBER

CY93-01

December 1982

Honeywell

About This Manual

This manual explains the operation of the PRU7070/7071 and PRU7075/7076 printers. Before using the printers, Honeywell recommends that you read this manual completely, especially Appendix B which explains the set-up procedures for the printers.

Section 1 gives a brief description of the printers, outlining their features and differences. An explanation of the main controls and indicators is found in Section 2. Operating procedures, complete with labeled photos, are detailed in Section 3. Section 4 provides programming information and details the commands for the printers. A functional description of the printers is given in Section 5.

The Appendixes describe the technical aspects of the printers and their operation. Appendix A explains the internal configuration controls. Appendix B discusses shipping procedures, installation, maintenance, cable connection, and jumper positioning. Printer specifications are given in Appendix C. Table C-2 in Appendix C should be referenced before ordering paper or ribbons for the printers. The correct media must be used to ensure satisfactory performance. Appendix D presents the ASCII Character Set and a summary of commands in sequence.

Most of the figures in this manual show the PRU7070/7071. Except for width and weight, the PRU7070/7071 is identical to the PRU7075/7076 in appearance, and any references to parts and their positions are the same.

Honeywell invites you to use the Technical Publications Remarks Form at the end of this manual to note any publications errors or to offer any suggestions for improvement.

Honeywell disclaims the implied warranties of merchantability and fitness for a particular purpose and makes no express warranties except as may be stated in its written agreement with and for its customer.

In no event is Honeywell liable to anyone for any indirect, special or consequential damages. The information and specifications in this document are subject to change without notice.

Contents

Section 1. Introduction

Section 2. Controls and Indicators

POWER ON/OFF Switch	2-1
Operation Panel	2-2
Operation Panel Switches	2-2
ON LINE/OFF LINE (and PRINT-TEST)	2-2
FORM FEED	2-3
Operation Panel Indicator Lights	2-3
ON LINE	2-3
POWER ON	2-3
Additional Operation Controls	2-4
Paper Movement Knob	2-4
Sprocket Lock Knobs and Covers	2-4
Self-Checking Capability	2-4

Section 3. Operation

Power On and Startup Procedure	3-1
PRINT-TEST Procedure	3-2
ON LINE/OFF LINE Status Procedure	3-3
FORM FEED Procedure	3-3
Power Off Procedure	3-4
Self-Checking Procedures	3-4
Paper Loading and Alignment Procedure	3-7
Ribbon Changing Procedure	3-8

Section 4. Printer Commands and Programming Information

Rules for Attribute Combinations	4-20
Parity Errors	4-20
Command Information	4-21

Section 5. Functional Description

Printing Approach	5-1
Normal Printing (10 CPI)	5-1
Compressed Printing (16.7 CPI)	5-2
Elongated Printing (Double-Width)	5-2
Line Graphics Printing	5-3
Underline Printing	5-3
Autoprint	5-4
Line Densities	5-4
Data Buffering	5-4
Form Length Selection	5-4
External Interfaces	5-5

Appendix A. Configuration Controls

Form Length Selection	A-3
-----------------------------	-----

Appendix B. Maintenance, Shipping, and Installation Procedures

Maintenance	B-1
Shipping and Installation	B-1
Unpacking the Unit	B-1
Packing the Unit	B-2
Host-Printer Connection	B-2
Direct Connection	B-3
Modem Interface Connection	B-4
Data Cable Connecting Procedure	B-4
Cable Connection for the PRU7070/7075 Printers	B-4
Cable Connection for the PRU7071/7076 Printers	B-5
Positioning the Jumpers	B-5
Jumper Positions for the TOP Set of Gold Pins	B-7
Jumper Positions for the BOTTOM Set of Gold Pins	B-7

Appendix C. Specifications

Appendix D. ASCII Character Set and Command Sort List

Figures

1-1	PRU7070/7071 Printer	1-1
1-2	PRU7075/7076 Printer	1-1
2-1	POWER ON/OFF Switch Shown in the OFF Position	2-1
2-2	Operation Panel	2-2
2-3	Paper Movement Knob	2-5
2-4	Internal Mechanics of the Printer	2-5
3-1	Power Cord and Data Cable Receptacle	3-1
3-2	Sample PRINT-TEST Output	3-3
3-3	Paper Chute	3-6
3-4	Internal Mechanics with Loaded Paper	3-7
3-5	Ribbon Cartridge	3-9
5-1	Actual 10.0 CPI Size and Width	5-1
5-2	Actual 16.7 CPI Size and Width	5-2
5-3	Actual Output for Double-Width Characters	5-3
B-1	Host-Printer Connection	B-3
B-2	Jumper and Pins	B-5
B-3	Blue Jumpers Covering Two Sets of Gold Pins	B-6
B-4	Two Sets of Gold Pins	B-6
B-5	Graphic Representation of 3 Gold Pins on the Printer Circuit Board	B-7

Tables

4-1	Codes for Line Graphics Symbols	4-5
4-2	Form Length Commands	4-7
A-1	Internal Switch Settings	A-2
A-2	Form Length Selection by Internal Switch	A-3
B-1	Bell System Asynchronous Data Sets	B-4
C-1	Print Characteristics	C-2
C-2	Media Specifications	C-3
D-1	PRU7070/7071 & PRU7075/7076 ASCII Character Set	D-1
D-2	Command Sort List of ASCII, Hexadecimal, Octal, and Mnemonic Assignments	D-2

Section 1

Introduction

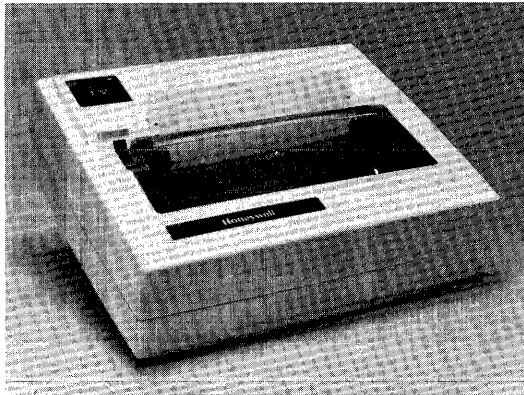

Figure 1-1. PRU7070/7071 Printer

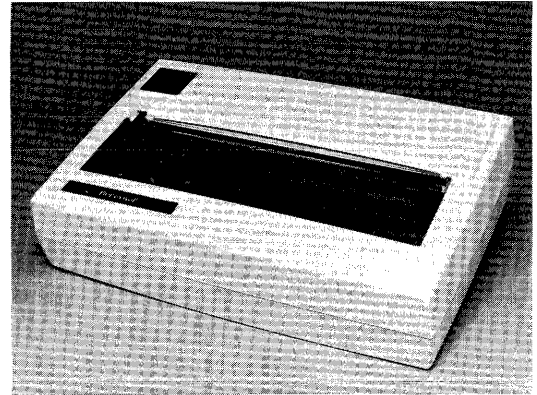

Figure 1-2. PRU7075/7076 Printer

Honeywell's PRU7070/7071 and PRU7075/7076 printers are compact, light-weight, quiet, desktop printers that have been designed specifically for use in office environments. The following features have been incorporated to provide convenience, simplified operation, speed, and flexibility. Each printer:

- Has both RS-422-A and RS-232-C interfaces
- Has efficient, bidirectional, logic-seeking print function
- Prints 100 characters-per-second
- Prints the full set of uppercase and lowercase alphabet characters as well as numerics, special symbols, and underscore
- Prints 11 line graphics symbols
- Prints elongated characters (double width) for highlighting
- Prints 80 or 132 characters-per-line for the PRU7070/7071 and 132 or 220 characters-per-line for the PRU7075/7076 allowing printout to be stored like any office correspondence

- Prints 6 or 8 lines per inch so most common forms can be accommodated
- Prints an original and up to two copies of forms from 3 to 10 inches wide for the PRU7070/7071 and forms from 3 to 15 inches wide for the PRU7075/7076
- Provides a form feed switch to advance paper
- Accommodates forms from 3.5 to 14 inches long
- Uses cartridge ribbon with Mobius loop to ensure clean ribbon changing
- Checks characters for parity errors before printing and either prints a diamond in place of any character in error or requests data block retransmission
- Initiates a local test to proof operation
- Provides ID and complete device status to host on request

The printers have the reliable design and wide performance range that make them an intelligent choice for any business, and they can fit comfortably wherever Honeywell systems are used in applications.

The printers have many features that come standard including an internal switch-enabled automatic line feed on carriage return, a paper-out detector located approximately two inches below the printing line, and a paper tear bar. An easily accessible operator panel mounted on the printer cover allows the operator to control online/offline status, form feed, and the execution of an internal print-test.

Section 2

Controls and Indicators

This section describes the functions of the controls and indicators of the printers.

POWER ON/OFF Switch

This switch, which is used to turn the power on or off and initialize the printer, is located under the printer in the right rear corner. See Figure 2-1, which shows the bottom of the printer.

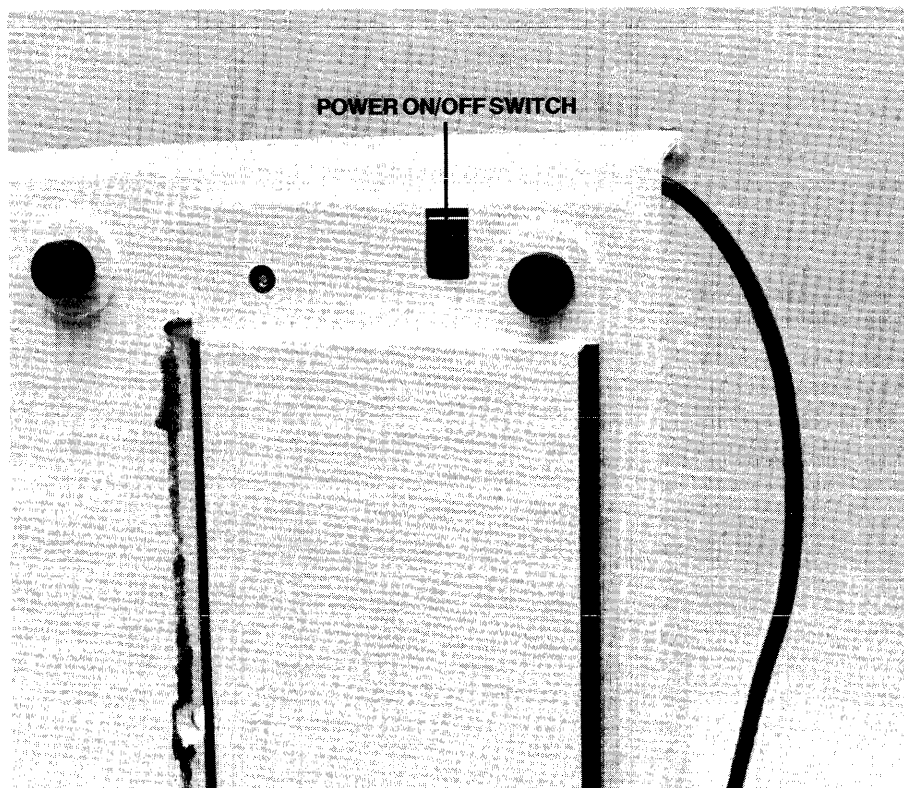

Figure 2-1. POWER ON/OFF Switch Shown in the OFF position

Operation Panel

The Operation Panel (Figure 2-2) is located on the top of the cover in the left rear corner of the printer. The panel consists of two switches (ON LINE/OFF LINE and FORM FEED) and two indicator lights (ONLINE and POWER ON).

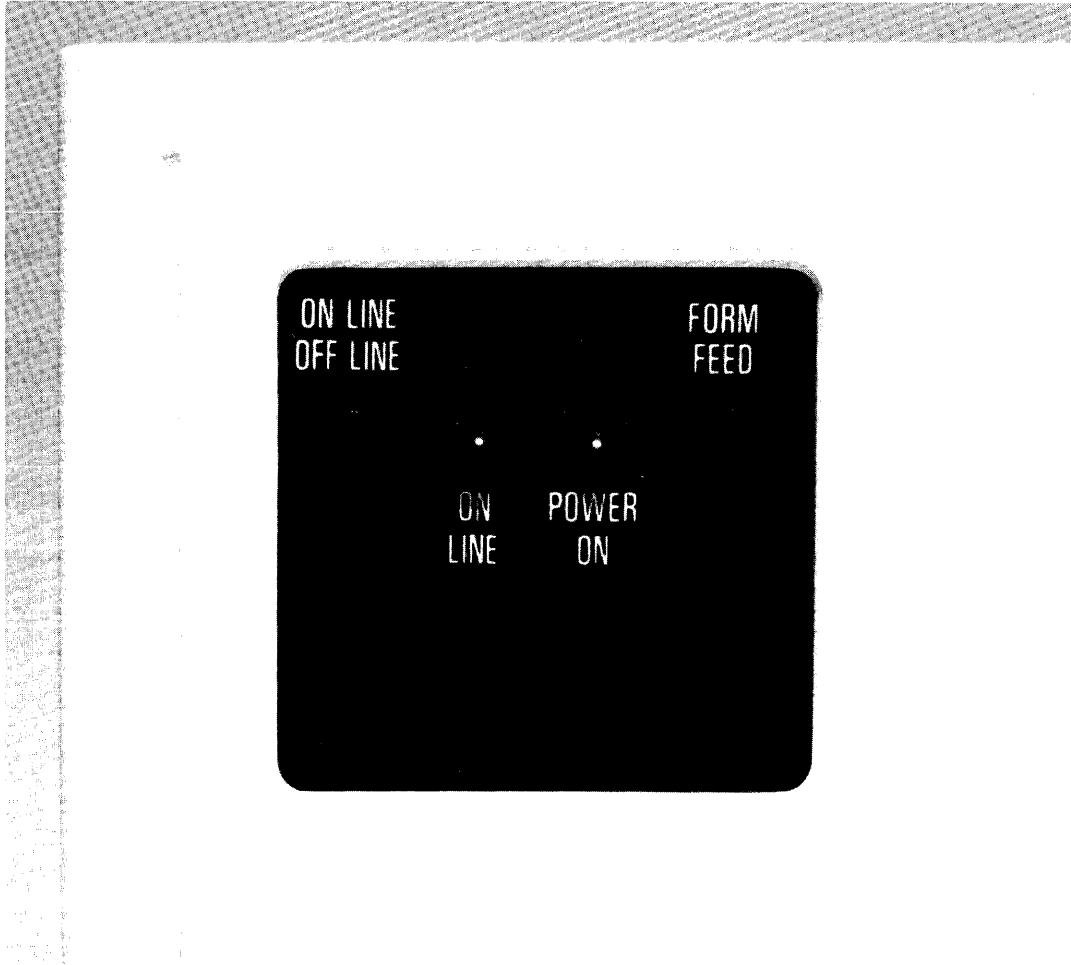

Figure 2-2. Operation Panel

Operation Panel Switches

ON LINE/OFF LINE (and PRINT-TEST)

This switch allows you to change the printer status. When this switch is pressed while the printer is online, the printer will go offline. When this switch is pressed while the printer is offline, the printer will go online.

When the printer is online, the ONLINE indicator will be lit, and the printer is able to receive data from the directly connected controller or adaptor.

When the printer is offline, the ONLINE indicator will not be lit, no data can be received from the controller or adaptor, paper can be loaded, and a local form feed can be performed.

The Print-Test procedure explained in Section 3 must be initiated immediately after powering on by pressing the ON LINE switch.

FORM FEED

This switch allows you to perform a FORM FEED procedure when the ON LINE indicator is not lit. The FORM FEED procedure advances the paper to the beginning of the next form if the paper has been properly aligned using the Paper Movement Knob, Figure 2-3. This procedure has no effect if the ONLINE indicator is lit.

Operation Panel Indicator Lights

ONLINE

When this indicator is lit, the printer is available to receive print data immediately from the controller.

Note: The FORM FEED and PRINT-TEST procedures *cannot* be performed when this indicator is lit.

When this indicator *blinks*, either a fault has occurred or the printer is out of paper. See the SELF-CHECKING procedure in Section 3 to handle this problem.

When the ON LINE indicator is not lit, the printer cannot receive messages from the controller.

POWER ON

When this indicator is lit, the printer is ON. The POWER ON/OFF switch must be turned ON before this indicator will light.

Additional Operation Controls

Paper Movement Knob

This knob is a black, wheel-shaped knob that protrudes through the top cover and is located to the left of the platen. The paper movement knob allows you to move the paper up or down and position the paper wherever desired. See Figure 2-3.

Sprocket Lock Knobs and Covers

These knobs and covers allow you to position the paper from side to side, adjust the sprockets to the width of the paper, and correct any strain on the paper. See Figure 2-4. The PAPER LOADING AND ALIGNMENT procedure in Section 3 explains how to use the sprocket lock knobs and covers.

Self-Checking Capability

The printers feature the capability to check printing performance for faults that may occur during operation. Before being printed, data received from the controller is checked for parity errors. If any character has incorrect parity, the printers, under switch control, will print a diamond in place of any characters that are received in error or request that the data block be retransmitted by the host system.

When the POWER ON/OFF switch is turned on, the printers will perform an initialization routine, a fault check, and a paper-out check to verify that they are operable. When this check has been successfully completed, the ON LINE indicator will be lit, the host system will be notified, and normal usage can begin. If a printer fault or paper out is detected, the ON LINE indicator will blink to indicate that the printers cannot be used, and the host system will be notified. See Section 3 for an explanation of the SELF-CHECKING procedure.

You can have the printers perform a Print-Test of their ability to operate properly by using the Print-Test procedure explained in Section 3.



Figure 2-3. Paper Movement Knob

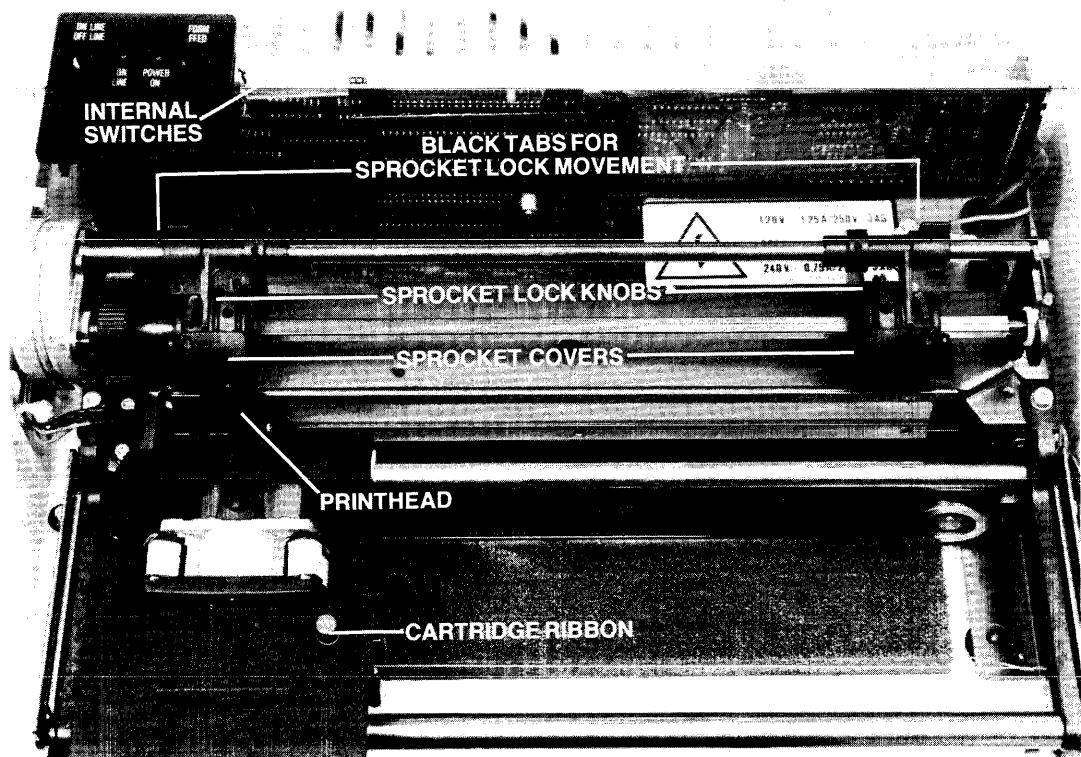

Figure 2-4. Internal Mechanics of the Printer

Section 3

Operation

This section describes the procedures necessary to operate the printers. Honeywell recommends that anyone using the printers first read through all of the steps *before* performing any procedure.

Power On and Startup Procedure

1. Check to see that the power cord is plugged into the ac wall outlet. See Figure 3-1.
2. Check to see that the data cable is connected properly to the printer. Figure 3-1 shows the receptacle for the data cable. If the data cable is not connected to the printer, follow the connecting procedures in Appendix B.

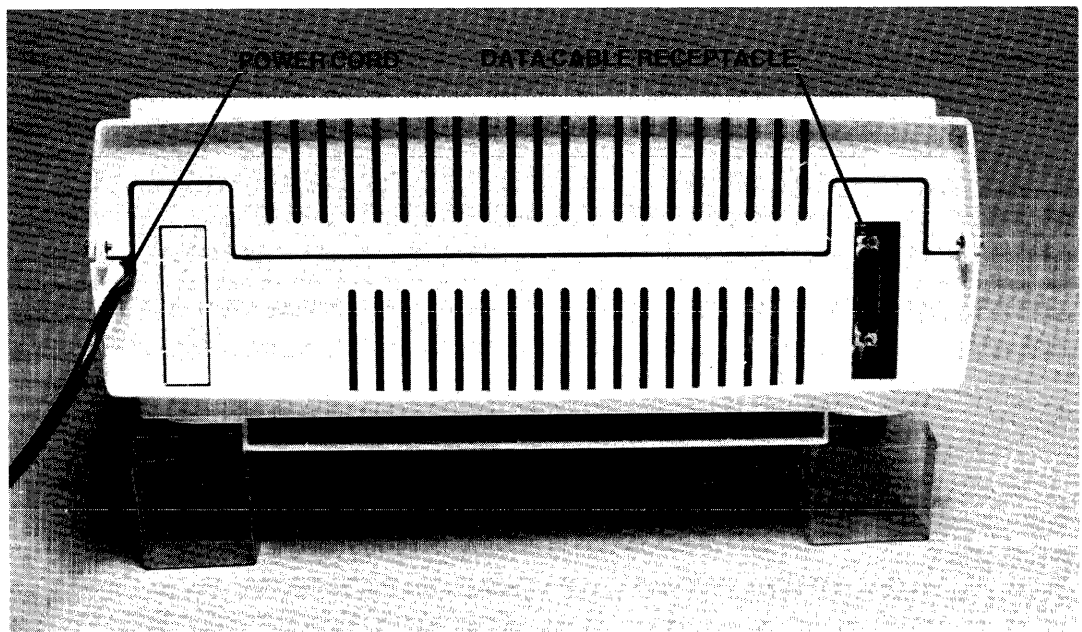

Figure 3-1. Power Cord and Data Cable Receptacle

3. If paper needs to be loaded into the printer at this time, see the "Paper Loading and Alignment Procedure" later in this section.
4. Locate the POWER ON/OFF switch on the bottom right rear of the printer. See Figure 2-1.
5. Turn the printer on by pulling the POWER ON/OFF switch toward the front of the printer to the ON position.
6. Check to see if the POWER ON indicator is lit on the Operation Panel (see Figure 2-2). The ON LINE indicator will also light after a short delay. If the POWER ON indicator is not lit, check first to ensure that the power outlet is active. This can be done by plugging in a lamp and seeing if it lights. If the power outlet is working, turn off the printer and call your Customer Services Representative.

Note: If the printer is not used for a few days (e.g., after a weekend), the exposed section of ribbon will become dry. Before you use the printer again, you should advance the ribbon by turning the red ribbon advance knob clockwise (see Figure 3-5) until a new section of ribbon is positioned in front of the printhead.

Print-Test Procedure

1. Turn on the printer by pulling the POWER ON/OFF switch (Figure 2-1) toward the front of the printer.
2. Immediately after you turn on the printer, press the ON LINE/OFF LINE switch located on the Operation Panel.

Note: Do not hold down the ON LINE/OFF LINE switch. Just quickly press it to begin the Print-Test procedure. A delay of more than two seconds between powering on and pressing the ON LINE switch will abort the Print-Test. Powering the printer off then on again will be necessary to retry the Print-Test. Check the Operation Panel to see if the ON LINE indicator is lit. It should *not* be lit during the Print-Test procedure. The Print-Test procedure will not be performed if the ON LINE/OFF LINE switch is pressed either too quickly or too long after the power is turned on. If you are unsuccessful starting the Print-Test, try it again until you get the correct timing.

3. Allow the printer to print 16 lines so that all of the characters will be printed for your examination. See Figure 3-2.

3. Locate the FORM FEED switch on the Operation Panel.
4. Press the FORM FEED switch on the Operation Panel to perform the FORM FEED procedure. The paper should advance to the top of the next form, if the paper has been loaded and aligned properly. If the form does not advance as expected, check the form length switch settings. See Table A-2.

Power Off Procedure

1. Locate the POWER ON/OFF switch on the bottom right of the printer (Figure 2-1).
2. Press the switch away from you to the OFF position.
3. Check the two indicator lights on the Operation Panel. Neither of them should be lit.

Self-Checking Procedures

The following situations may occur when you are operating the printer. If your printer is not operating properly, you should check the internal switch settings that are described in Appendix A to see if all 12 switches are set properly. You should also check the positions of the two blue jumpers on the two sets of gold pins that are described in Appendix C. Correct switch and jumper positions are required for normal printer operation.

1. A diamond is printed in place of a normal character.
This probably means: The printer has received an incorrect character.
You should:
 - a. Check to see that the data cable is connected securely to the printer. See Figure 3-1.
 - b. Check to see that the power cord is plugged into the wall socket securely.
 - c. If the data cable and power cord are both secure, you may have a more serious problem and should call your Customer Services Representative.
2. A series of diamonds is printed in place of characters.
This probably means: A switch is set wrong.
You should:
 - a. Read Appendix A for correct switch settings.
 - b. If all switches are set properly, call your Customer Services Representative.

3. The ONLINE indicator is blinking.
This probably means: You are out of paper or you have a fault condition.
You should:
 - a. Determine that the paper supply is adequate and that the paper is not torn, which can expose the Paper Out switch (located 2 inches below the print line).
 - b. If paper out is not the problem, place the printer in the offline state and then return the printer to the online state.
 - c. If the indicator continues to blink, turn off the power to the printer and call your Customer Services Representative.
4. One line is printing over another because the paper is not advancing.
This probably means: The punched holes on the sides of the paper have been torn or you have a printer failure.
You should:
 - a. Lift up the sprocket lock covers (Figure 2-4) and check to see if the punched holes on the sides of the paper are torn.
 - b. If these holes are torn, lift both the left and right sprocket covers and remove the piece of paper with the torn holes.
 - c. Move the remaining paper manually so that new holes can be positioned over the sprocket teeth.
 - d. Close the sprocket covers and use the Paper Movement Knob to advance the paper to the next top-of-form.
 - e. If the paper holes are not torn, you may have a more serious problem and should call your Customer Services Representative.
5. One line is overlapping or printing over another.
This probably means: The blue jumper on the BOTTOM set of gold pins is covering the wrong gold pins.
You should:
 - a. Reposition the blue jumper according to the requirements given in Appendix B.
 - b. If the printer continues to operate improperly, call your Customer Services Representative.
6. Too much space is occurring between printed lines.
This probably means: The blue jumper on the BOTTOM set of gold pins is covering the wrong gold pins.
You should:
 - a. Reposition the blue jumper according to the requirements given in Appendix B.

- b. If the printer continues to operate improperly, call your Customer Services Representative.
7. The printer is not communicating at all.

This probably means: The blue jumper on the TOP set of gold pins is covering the wrong gold pins.

You should:

- a. Reposition the blue jumper according to the requirements given in Appendix B.
 - b. If the printer continues to operate improperly, call your Customer Services Representative.
8. Paper is not advancing.

This probably means: There is an internal paper jam, or you have a printer failure.

You should:

- a. Check the paper chute (Figure 3-3) on the back of the printer to see if paper coming out of the top of the printer is resting on the top of the paper entering the paper chute.
 - b. If paper from the top of the printer is also entering the paper chute, remove it by pulling out all paper in the chute.
 - c. Open the printer cover and remove any excess paper causing the paper jam.
 - d. Reload new paper.
 - e. If an internal paper jam is not the problem, you may have a more serious problem and should call your Customer Services Representative.

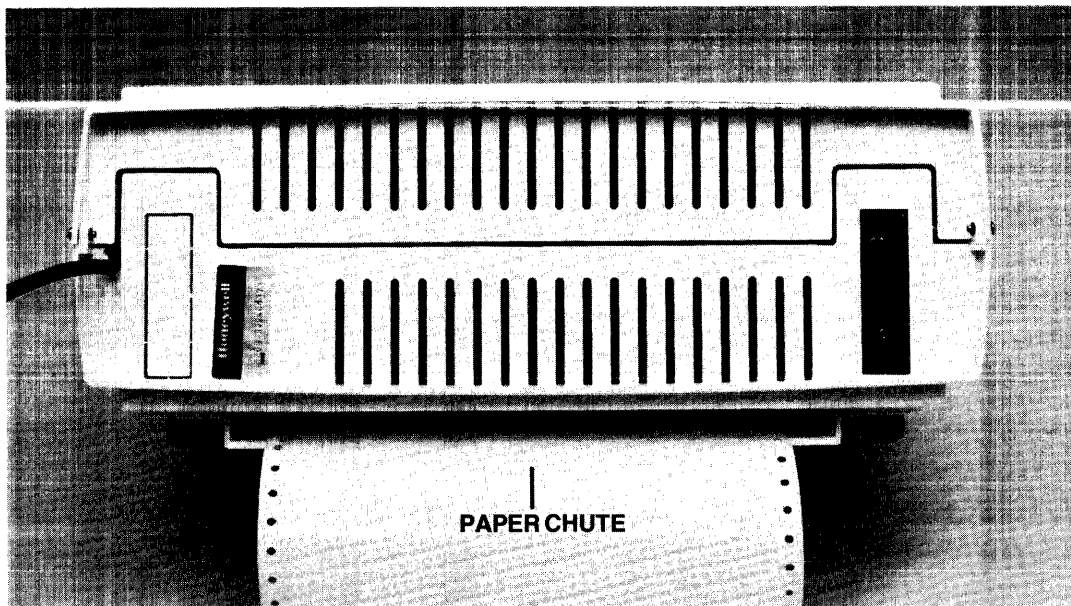

Figure 3-3. Paper Chute

Paper Loading and Alignment Procedure

The printers have this easy procedure for loading paper:

1. Position the stack of paper behind the printer.
2. If using single copy paper, take the top sheet of paper and fold it onto the attached second sheet. This makes the loading procedure easier.
3. Open the printer by pulling the cover up and away from you.
4. With both hands, feed the folded paper into the paper chute (Figure 3-3) located under the printer. Keep feeding the paper into the chute until you see the top of the paper appear just above the protective plastic shield under the platen. See Figures 2-4 and 3-4.
5. Turn on the printer to allow the printhead to position itself to the left of the platen. This will happen automatically. Figure 3-4 shows the proper loading position for the printhead.

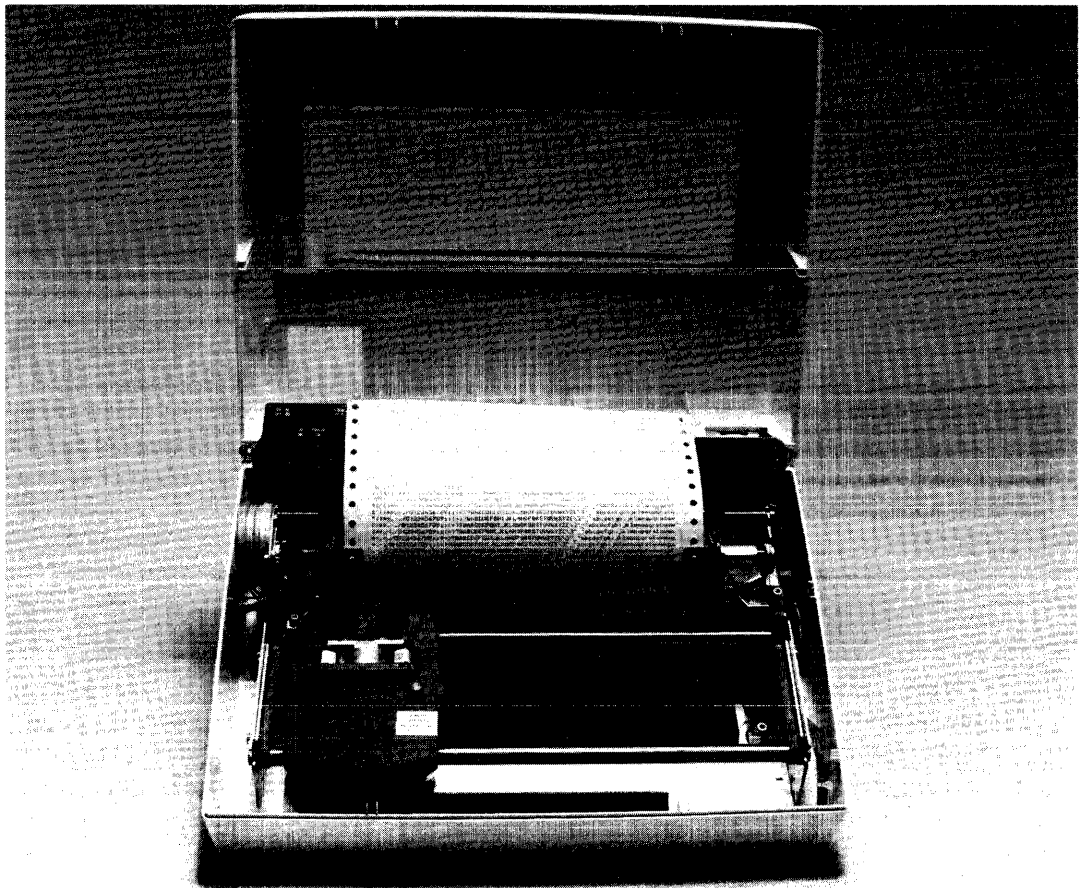

Figure 3-4. Internal Mechanics with Loaded Paper

Note: If the paper is narrower or wider than the paper that was previously in the printer, the sprocket locks must be adjusted. See Figure 2-4. You can adjust the sprocket locks by pulling the black tab toward you and moving the sprocket lock to the desired position to hold the paper. Push the black tab back to secure the sprocket lock. The left sprocket must be positioned first and must be to the left of the leftmost printhead position.

6. Check to see that the left sprocket is positioned to the left of the leftmost printhead position. Pull out the *left* sprocket lock cover (Figure 2-4) and position the left margin of the paper by aligning the holes in the paper with the sprockets on the wheel under the sprocket lock cover. Gently snap the sprocket lock cover back into position.
7. Pull out the right sprocket lock cover (Figure 2-4) and position the right margin of the paper. If necessary, adjust the right sprocket lock. See the procedure in the Note under Step 5. Gently snap the sprocket lock cover back into position.
8. Close the printer cover while guiding the top of the paper through the opening in the printer cover. See Figure 3-4.
9. Adjust the top of the form by moving the black Paper Movement Knob back and forth. See Figure 2-3. The top of the form is the first line where you expect printing to appear. The printhead should be at that line. You may now perform the ONLINE, PRINT-TEST, or FORM FEED procedure. The ONLINE procedure must be performed before the printer can receive information from the controller.

Note: When printing starts, you must ensure that the first few forms coming out of the printer are stacked properly in back of the printer. This attention is necessary to avoid paper dropping over the back of the printer and resting on top of the paper entering the paper chute (Figure 3-3), which could cause an internal paper jam.

Ribbon Changing Procedure

The printers provide a clean, compact ribbon cartridge package that snaps in and out of place easily and quickly. To change the ribbon cartridge, follow this procedure:

1. Open the printer by lifting the cover up and away from you.
2. Lift out the ribbon cartridge by grasping it on both sides and pulling it upward toward you. The cartridge should easily snap out of position.

3. Remove the new cartridge from its cellophane packaging.
4. Pull out, remove, and dispose of the *spring clamp* located on the right side of the new cartridge. See Figure 3-5.
5. Turn the red knob on the top of the cartridge clockwise to tighten the ribbon tension.
6. Fit the ribbon over the front of the printhead and insert the cartridge into the same place where the old cartridge was. It should easily snap into place. Adjust the ribbon tension, if necessary, by turning the red tension knob on the top of the cartridge clockwise.

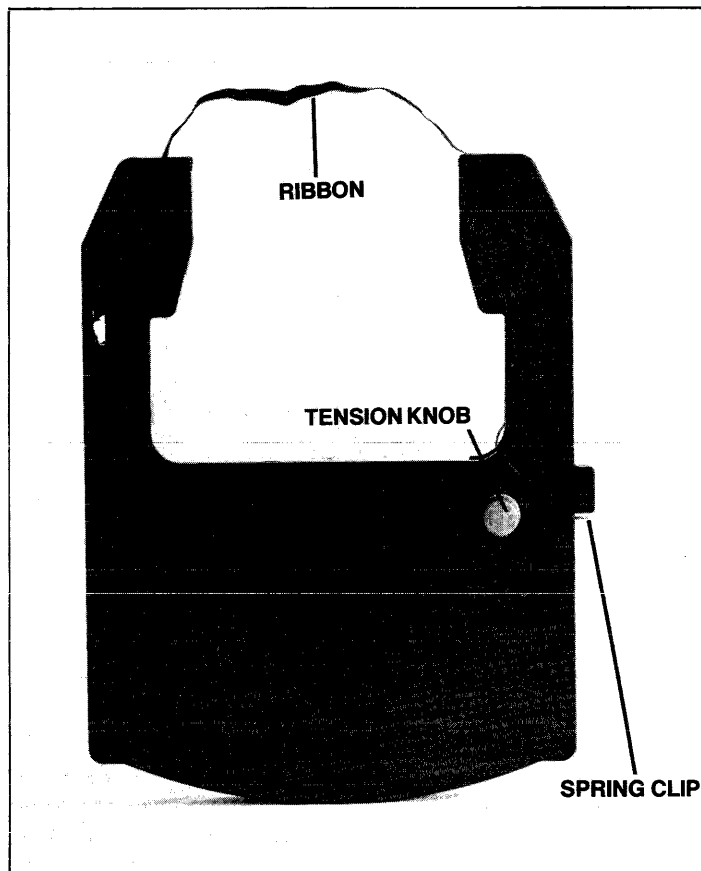

Figure 3-5. Ribbon Cartridge

Section 4

Printer Commands and Programming Information

This section describes the various operating commands used by the printers and gives other pertinent programming information. The commands are arranged in a categorical format, listing the name of the command, its ASCII code, and both the hexadecimal and octal equivalents for the code. This is followed by a description of the command function.

Command Name: SET 16.7 CPI PITCH

ASCII Code: ESC s 8

Hexadecimal: 1B-73-38

Octal: 033-163-070

Function:

This command overrides the internal switch setting and sets character spacing to 16.7 cpi. Initially the character spacing is determined by internal switch setting (see Appendix A). Print character spacing can be changed by software at any time except in the middle of a line by sending the printer the appropriate command immediately following the CR/LF from a previous line. Pitch is not changed by the Restore attribute. At RESET TO INITIAL STATE (RIS), pitch returns to the internal switch setting.

If characters of a different pitch are to be printed on the same line, the software should send a CR (No LF) followed by the new pitch assignment and characters that are properly spaced to account for previously printed characters effectively printing twice on the same line. Unlike the double-width attribute, the spacing is not based on a simple character count, so great care should be taken when using multiple pitches per line. When printing the first pass at initial pitch, printing an 80th or 132nd character will initiate an automatic line feed causing the second pass to print on the next line.

At 16.7 cpi, 132 characters can be printed in the 8 inch space normally occupied by 80 characters at 10 cpi. The PRU7075/7076 allows printing of 220 characters in the 13.2 inch space normally occupied by 132 characters at 10 cpi.

Command Name: SET 10 CPI PITCH

ASCII Code: ESC s 5

Hexadecimal: 1B-73-35

Octal: 033-163-065

Function:

This command overrides the internal switch setting and sets the character spacing to 10 cpi. Initially the character spacing is determined by internal switch setting (see Appendix A). Print character spacing can be changed by software at any time except in the middle of a line by sending the printer the appropriate command immediately following the CR/LF from a previous line. Pitch is not changed by the Restore attribute. At RESET TO INITIAL STATE (RIS), pitch returns to the internal switch setting.

If characters of a different pitch are to be printed on the same line, the software should send a CR (no LF) followed by the new pitch assignment and characters that are properly spaced to account for previously printed characters, effectively printing twice on the same line. Unlike the double-width attribute, the spacing is not based on a simple character count, so great care should be taken when using multiple pitches per line. When printing the first pass at initial pitch, printing an 80th or 132nd character will initiate an automatic line feed causing the second pass to print on the next line.

Command Name: SET LINE GRAPHICS

ASCII Code: ESC G

Hexadecimal: 1B 47

Octal: 033 107

Function:

The LGS command sets the printer to Line Graphics mode when it follows a carriage return, CR or CR, LF. When the printer is in this mode, only graphics characters can be generated for printing. Eleven graphics symbols can be generated by selected codes. These codes are taken from the ASCII set shown in Appendix D and are shown in Table 4-1. In addition, CR, LF and LGR are effective. Other commands, including attributes DWC and CUS, are ignored.











Line graphics can be printed at either 10 cpi or 16.66 cpi, but line density must be 6 lpi. Line graphic codes following LGS are separated into print lines by CR, LF at the end of each line. Each line is printed in two passes at half-line feed. After the second pass, the end-of-line feed command causes a second half-line feed. It is important that the final LF command be given before leaving the graphics mode, otherwise a full line feed will occur.

It is possible to insert text into a line graphic pattern by resetting the graphic mode at the completion of a line. The inserted text must be spaced to accommodate the graphic pattern. After the text is printed, a CR followed by LGS allows overprinting the text line with line graphics. For boxing text, the text is inserted after the top of the box is programmed and the bottom is then overprinted.

Line graphics always require a print command (CR). After a timeout with data stored, automatic printout occurs for normal data but not for line graphics.

Inserted text can be in either condensed or double-width mode. If characters of a different pitch are to be inserted on the same line, the software will send a CR (no LF) followed by the new pitch assignment and characters that are properly spaced to account for previously printed characters effectively inserting two text strings on the same line. Unlike the double-width attribute, the spacing is not based on a simple character count, so great care should be taken when using multiple pitches per line. When printing the first pass at initial pitch, printing an 80th or 132nd character will initiate an automatic line feed causing the second pass to print on the next line.

Table 4-1. Codes for Line Graphics Symbols

Symbol	ASCII	Hexadecimal	Octal
Space	SP	20	040
	A	41	101
	B	42	102
	C	43	103
	D	44	104
	E	45	105
	F	46	106
	G	47	107
	H	48	110
	I	49	111
	J	4A	112
	K	4B	113

LGR

LGR

Command Name: RESET LINE GRAPHICS

ASCII Code: ESC F

Hexadecimal: 1B 46

Octal: 033 106

Function:

The LGR command takes the printer out of Line Graphics mode; otherwise, LGR is ignored.

Command Name: SET FORMLENGTH

ASCII Code: ESC "SPACE" "XY"

Hexadecimal: 1B-20-"XY"

Octal: 033-040-"XY"

Function:

This command overrides the internal switch settings and sets specific form lengths that are defined as a number of lines. Common lengths defined in inches can be selected by an operator setting the easily accessible switches (see Table A-2 in Appendix A). These lengths or other varying lengths can be down-loaded via the FLS command, but they must be expressed in the number of lines per form. Line density and length in number of lines must be considered when setting the form length. When the form length is down-loaded, the current physical print line position becomes the first logical line of the form. Down-loaded form length is saved while the printer is offline. Reset or power up returns form length to the selected switch value.

XY values are hexadecimal digits represented by an ASCII code in the range of 21 through 7E (see Table D-1 in Appendix D). The value 21 corresponds to a form length of one line; the value 7E corresponds to a form length of 94 lines; values 20 and 7F are ignored.

Table 4-2 gives the Form Length Commands, listing the number of lines, the ANSI character, the hexadecimal code, and the octal code.

Table 4-2. Form Length Commands

Number of Lines	ANSI Character	XY Hexadecimal Code	UVW Octal Code
1	!	21	041
2	"	22	042
3	#	23	043
4	\$	24	044
5	%	25	045
6	&	26	046
7	'	27	047
8	(28	050
9)	29	051

Table 4-2 (Cont). Form Length Commands

Number of Lines	ANSI Character	XY Hexadecimal Code	UVW Octal Code
10	*	2A	052
11	+	2B	053
12	,	2C	054
13	-	2D	055
14	.	2E	056
15	/	2F	057
16	0	30	060
17	1	31	061
18	2	32	062
19	3	33	063
20	4	34	064
21	5	35	065
22	6	36	066
23	7	37	067
24	8	38	070
25	9	39	071
26	:	3A	072
27	;	3B	073
28	<	3C	074
29	=	3D	075
30	>	3E	076
31	?	3F	077
32	@	40	100
33	A	41	101
34	B	42	102
35	C	43	103
36	D	44	104
37	E	45	105
38	F	46	106
39	G	47	107
40	H	48	110
41	I	49	111
42	J	4A	112
43	K	4B	113
44	L	4C	114
45	M	4D	115
46	N	4E	116
47	O	4F	117
48	P	50	120

Table 4-2 (Cont). Form Length Commands

Number of Lines	ANSI Character	XY Hexadecimal Code	UVW Octal Code
49	Q	51	121
50	R	52	122
51	S	53	123
52	T	54	124
53	U	55	125
54	V	56	126
55	W	57	127
56	X	58	130
57	Y	59	131
58	Z	5A	132
59	[5B	133
60	\	5C	134
61]	5D	135
62	^	5E	136
63	_	5F	137
64	`	60	140
65	a	61	141
66	b	62	142
67	c	63	143
68	d	64	144
69	e	65	145
70	f	66	146
71	g	67	147
72	h	68	150
73	i	69	151
74	j	6A	152
75	k	6B	153
76	l	6C	154
77	m	6D	155
78	n	6E	156
79	o	6F	157
80	p	70	160
81	q	71	161
82	r	72	162
83	s	73	163
84	t	74	164
85	u	75	165
86	v	76	166
87	w	77	167

Table 4-2 (Cont). Form Length Commands

Number of Lines	ANSI Character	XY Hexadecimal Code	UVW Octal
88	x	78	170
89	y	79	171
90	z	7A	172
91	{	7B	173
92		7C	174
93	}	7D	175
94	~	7E	176

LDS

LDS

Command Name: SET 6 LPI

ASCII Code: ESC U

Hexadecimal: 1B-55

Octal: 033-125

Function:

This command overrides the internal switch setting and sets the line density at 6 lines-per-inch. The switch set value of 8 lines-per-inch can be overridden by LDS and changed to the alternate value. The down-loaded line density value is saved when the printer is offline. Line density changes should be made at the beginning of a message. The new form length must also be entered at the same time by FLS, otherwise page synchronization is lost on the next Form Feed command.

LDE

LDE

Command Name: SET 8 LPI

ASCII Code: ESC u

Hexadecimal: 1B-75

Octal: 033-165

Function:

This command overrides the internal switch setting and sets the line density at 8 lines-per-inch. The set value of 6 lines-per-inch can be overridden by LDE and changed to the alternate value. The down-loaded line density value is saved when the printer is offline. Line density changes should be made at the beginning of a message. The new form length must also be entered at the same time by FLS, otherwise page synchronization is lost on the next Form Feed command.

Command Name: SET DOUBLE WIDTH

ASCII Code: ESC s 2

Hexadecimal: 1B-73-32

Octal: 033-163-062

Function:

This command allows the printing of elongated characters, doubling the width of the current horizontal character and the inter-character space. Using this printing attribute, it is possible to print lines up to 40/66 elongated normal characters or up to 66 elongated compressed characters (8.33 characters per inch). Elongated printing is software selectable by means of the Set Double-Width Printing attribute. Elongated printing terminates when the Restore attribute or any new attribute is assigned. When an elongated character is going to be printed in the last printable column, the character is printed without the elongation attribute. The print speed is halved to 50 characters-per-second when this attribute is active.

Command Name: SET UNDERLINE

ASCII Code: ESC s _

Hexadecimal: 1B-73-5F

Octal: 033-163-137

Function:

This command allows a continuous underline on any character string. This function is performed during the same printing pass of the printhead using the ninth lower needle. Underlining is automatically discontinued by firmware on a true descender character as required by the font characteristics. The underline attribute is not automatically reset at the end of the received line. The Restore attribute or a new attribute must be received in order to close the underlined field. Underlined printing can be combined with any of the previously mentioned attributes of CPT, CPS, and DWC.

RSR

RSR

Command Name: RESTORE

ASCII Code: ESC s R
ESC s r

Hexadecimal: 1B-73-52
1B-73-72

Octal: 033-163-122
033-163-162

Function:

This command is used to reset all attributes except Pitch. Attributes are CPT, CPS, DWC, CUS.

Command Name: RESET TO INITIAL STATE

ASCII Code: ESC c

Hexadecimal: 1B-63

Octal: 033-143

Function:

This command is used by the driver as part of its function and is not expected to be issued by the application. The application can cause the driver to issue an RIS command to the printer under the rules for the operating system.

This command causes an immediate printer busy condition followed by an initialization routine, resets form length to the default setting, defines top-of-form, clears the buffer, positions the printhead to the leftmost position, and signals the Host system when complete.

FF

FF

Command Name: FORM FEED

ASCII Code: FF

Hexadecimal: 0C

Octal: 014

Function:

This command causes the printer to start printing the buffer content, if any, and to execute a form feed, moving the paper to the head of the next form even if the paper will run out during paper movement. When used in conjunction with the FLS command, the FF command provides a smooth, continuous movement for form advancement. A continuous movement is not produced from a sequence of LF commands.

LF

LF

Command Name: LINE FEED

ASCII Code: LF

Hexadecimal: 0A

Octal: 012

Function:

This command causes the execution of a line feed operation wherever encountered in the print line. A printer busy condition occurs while the line feed is executed. A sequence of line feed commands will cause a printer busy for each LF when executed.

CR

CR

Command Name: CARRIAGE RETURN

ASCII Code: CR

Hexadecimal: 0D

Octal: 015

Function:

This command causes the printer to start printing the buffer content, if any, and perform a line feed if the internal switch is set for line feed on carriage return (new line).

Rules for Attribute Combinations

Attributes can be combined according to these rules:

- Attributes are effective at the point where they appear in the data stream.
- Sequences of allowed attributes are closed by a subsequent printable character.
- Attributes are in force until receiving a new attribute or the Restore attribute.
- The Pitch attribute changes only by the assignment of a new pitch. Pitch assignments do not affect the other running attributes.

Parity Errors

When a parity error occurs and the request data block retransmission switch is not set, escape sequences are handled as follows:

- Escape code with a parity error — a diamond is printed for the Escape code received in error and the following codes of the sequences are printed.
- Sequences with a parity error — a diamond is printed in place of the character received in error and the preceding part of the sequence is discarded while the following sequence code is printed.
- If the request data block retransmission switch is set, no printing takes place until the block has been correctly received.

Command Information

The following commands common to these Honeywell printers: PRU1005/7005 and PRU1003/7003 will be ignored by the PRU7070/7071 and the PRU7075/7076 printers:

ESC	H	Online
ESC	J	Standby
ESC	3	Set vertical tab
ESC	4	Clear all vertical tabs
ESC	1	Tab set horizontal
ESC	2	Clear horizontal tabs
BEL		Bell
BS		Back space
HT		Horizontal tab
VT		Vertical tab

The BEL and VT commands used with Honeywell's PRU1018 printer will be ignored by the PRU7070/7071 and PRU7075/7076 printers.

Section 5

Functional Description

This section describes some of the functional characteristics of the PRU7070/7071 and the PRU7075/7076 printers employing a 9-needle printhead and providing 100 characters-per-second print speed at 10 or 16.7 characters-per-inch on a 9 x 7 dot matrix (vertical x horizontal).

Printing Approach

The carriage moves continuously during printing, which is started after reception of a data block. Printing is performed with the logic-seeking approach, which means that before a line is printed, the printer examines the actual position of the carriage and finds the left and right limits of the printable characters. Then the printer makes a decision whether to print forward or backward starting from left or right. In this way, the carriage movement without printing is minimized, and the actual throughput can reach higher values according to the actual print patterns. Printing is performed while the carriage is moving with a constant speed over the line length. Data reception is overlapped with the printing.

Normal Printing (10 CPI)

Character spacing is determined by internal switch setting (see Appendix A). Normal print character spacing can be changed by software by sending the printer the appropriate command at the beginning of a printable data line.

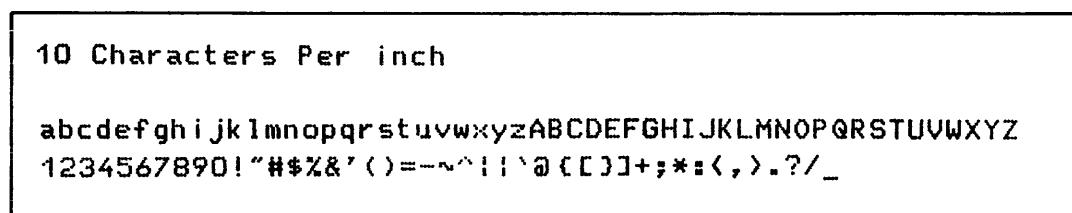

Figure 5-1. Actual 10.0 CPI Size and Width

Compressed Printing (16.7 CPI)

When the printers are powered up, character spacing is determined by internal switch setting (see Appendix A). Compressed printing can be selected by a "Set 16.7 CPI" command and disabled only by a "Set 10 CPI" command. Character density commands must be sent at the beginning of the line; character density cannot be changed when a line is printing.

Compressed characters are printed with an actual character pitch of 16.7 cpi, and their horizontal width and inter-character space is proportionally reduced.

When compressed printing is activated, the same print speed of that at 10 cpi is maintained and the other running attributes are not restored. In the PRU7075/7076, compressed line length printing is 220 characters that are left justified.

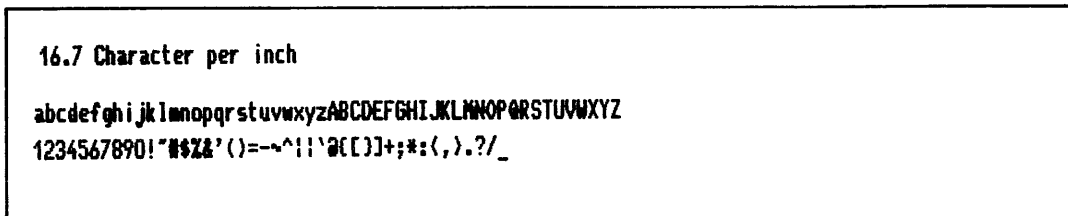

Figure 5-2. Actual 16.7 CPI Size and Width

Elongated Printing (Double-Width)

Elongated characters are printed, doubling the current horizontal character width and the inter-character space. Using this printing capability, it is possible to print lines up to 40 elongated normal characters or up to 66 elongated compressed characters (8.33 characters per inch) on the PRU7070/7071 and 66 or 110 characters on the PRU7075/7076.

Elongated printing is software selectable by means of the Set Double-Width Printing attribute. Elongated printing terminates when any new attribute or the Restore attribute is assigned.

When an elongated character is going to be printed in the last printable column, the character is printed without the elongation attribute. The print speed is halved to 50 characters-per-second when this attribute is active.

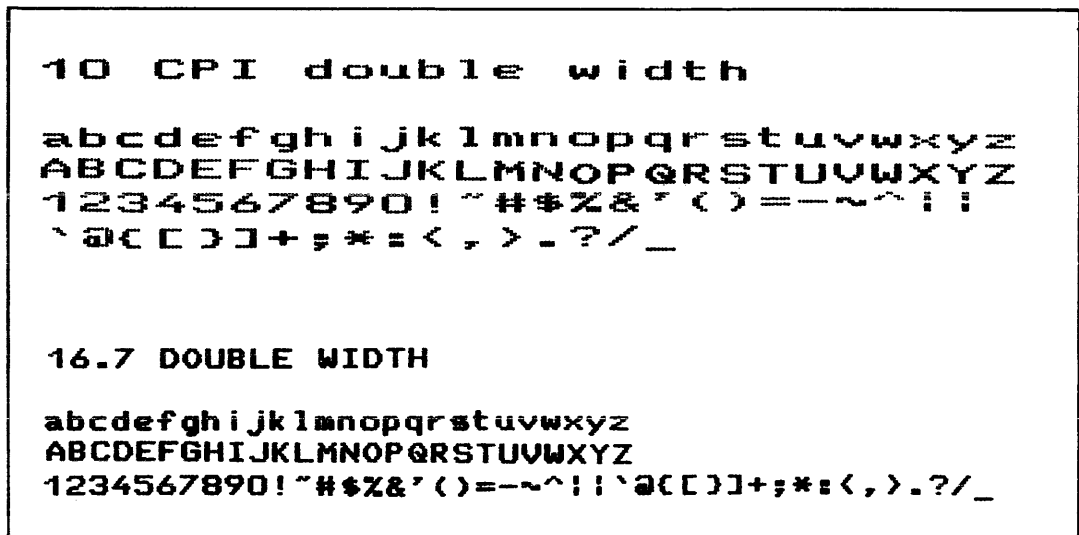

Figure 5-3. Actual Output for Double-Width Characters

Line Graphics Printing

Line Graphics printing provides the capability to generate contiguous horizontal and vertical lines. It can be used to outline forms, organize areas within a form, and construct simple charts.

Underline Printing

This feature allows a continuous underline on any character in the same line. This function is performed during the same printing pass of the printhead using the ninth lower needle.

Underlining is automatically discontinued by firmware on true descender characters as required by the font characteristics.

The underline attribute is not automatically reset at the end of the received line. The Restore attribute or a new attribute must be received in order to close the underlined field.

Underline printing can be combined with any of the previously mentioned printing attributes.

Autoprint

When the full line length (80 printable characters at 10 cpi or 132 characters at 16.7 cpi for the PRU7070/7071 or at 132 or 220 characters at 10 cpi or 16.7 cpi for the PRU7075/7076) is received without a carriage return/line feed command, the printer immediately prints the line of data followed by an automatic line feed and a column counter positioning to the first column.

After an autoprint execution, the first line feed received will be ignored if not preceded by printable characters that are string-closed by a print command. This eliminates the need for a LF when a full line is not ended by a CR plus LF or FF. Attributes are not reset by autoprint.

Line Densities

The default value can be selected by means of an internal switch between 6 or 8 lpi. These values can be overridden by software.

Down-loaded line density is saved when the printers are offline. The commands cannot be embedded between printable data of the same line.

Line density changes must be made at the beginning of a message. The new form length must be entered by software, otherwise page synchronization is lost on the next form feed command.

Data Buffering

The two printer data buffers each provide room for 127 ASCII codes that can be commands or printable characters. When the printer is placed offline, the buffer content is saved and then printed after the online state is reentered.

Form Length Selection

Form length can be selected by an operator setting the easily accessible switches (see Table A-2 in Appendix A). These lengths or other varying lengths can be down-loaded via software commands, but they must be expressed in the number of lines per form.

When the form length is down-loaded, the current physical line position becomes the first logical line of the form. Down-loaded form length is saved while the printers are offline.

External Interfaces

The printers come with a 25-pin receptacle connector in accordance with ISO-IS 211C physical dimensions. This connector allows a data signal exchange with the host via a suitable cable. Data transfer occurs in asynchronous transmission mode (start/stop) of serial-by-bit characters.

The printers include both RS-232-C and RS-422-A interfaces. A selection feature on the printer electronic board (PWA) is provided in order to select the proper interface at installation time (see Appendix B). The PRU7070 and PRU7075 are delivered with the proper cable for RS-422-A connection. The PRU7071 and PRU7076 are delivered with the proper cable for RS-232-C connection.

Appendix A

Configuration Controls

The printers are equipped with 12 internal switches (see Figure 2-4) located on the top left section of the printer circuit board. These switches alter various characteristics of the printer; however, Honeywell software is designed to control most of these functions for you, and it can override the switch settings. Table A-1 explains the function of each internal switch in both the ON and OFF positions.

Typically, the most common settings for the internal switches will be:

Switch	Position
1	OFF
2	ON
3	OFF
4	OFF
5	OFF
6	ON
7	OFF
8	ON ¹
9	OFF
10	OFF
11	OFF
12	OFF

The functions for these switch settings are explained in Tables A-1 and A-2.

Table A-1 explains the function of each internal switch in both the ON and OFF positions.

¹When switch 9 is ON, switch 8 will select 300 baud rather than 9600 baud if in the ON position.

Table A-1. Internal Switch Settings

Switch	ON	OFF	Function
1	X		Selects 8 lines per inch
		X	Selects 6 lines per inch
2	X		Selects parity error report
		X	Selects printing of diamond on parity error
3	X		Selects 16.7 characters per inch spacing
		X	Selects 10.0 characters per inch spacing
4	X		Selects the carriage return function and automatically inserts a line feed function after the carriage return
		X	Selects the carriage return function only
5,6,7	X	X	Select form lengths. See Table A-2
8	X		Selects 9600 baud if switch 9 is in the local (OFF) position (direct connect mode), or selects 300 baud if switch 9 is in the remote (ON) position (modem connect mode)
		X	Selects 1200 baud
9	X		Selects modem connect (remote)
		X	Selects direct connect (local)
10, 11, 12		X	Select character sets. These switches must always be OFF for the International Character Set.

A label explaining the internal switch settings will appear on the underside of the top cover of the printers just above the internal switches. Honeywell recommends that you mark the label on the printer cover with a colored pen according to the desired fixed settings. Should you accidentally hit the switches and knock them out of position, the marked label will show you the proper positions for the switches.

Form Length Selection

Form length can be selected in two ways:

- Internal switches that are accessible by you
- Software by the program in the host controller

Table A-2 explains the form length values that can be manually selected by internal switch before the printer is powered on. Software can override the switch settings.

Table A-2. Form Length Selection by Internal Switch

FL in Inches	FL in Number of Lines		Internal Switch Setting		
	6 LPI	8 LPI	5	6	7
3.5	21	28	ON	ON	ON
4	24	32	OFF	ON	ON
5.5	33	44	ON	OFF	ON
7	42	56	OFF	OFF	ON
8.5	51	68	ON	ON	OFF
11	66	88	OFF	ON	OFF
12	72	96	ON	OFF	OFF
14	84	112	OFF	OFF	OFF

Note: Each time a form length is changed by internal switch, the printer must be shut off and powered on again to obtain the desired form length.

Appendix B

Maintenance, Shipping, and Installation Procedures

Maintenance

No preventive maintenance on a scheduled basis is required.

Shipping and Installation

Packing and unpacking the printer involves simple procedures explained below. If you feel that a more detailed explanation of the set up procedure is needed, you can reference the *Setup Procedure for Printers PRU706X & PRU707X* manual, Order No. CY03.

Unpacking the Unit

1. Remove the printer from its protective package. *SAVE* the package in case you need to move the printer at a later date and store the protective material that comes with the printer in this package.
2. Remove the strip of tape located around the middle sides of the printer. Removing this tape will allow you to lift the printer cover.
3. Lift the printer cover up and away from you. The internal mechanics of the printer will be covered with protective material.
4. Remove this protective material from the internal mechanics and *SAVE* it in the protective package for future use.
5. Remove the cartridge ribbon from its plastic bag.
6. Follow the steps in Section 3 for the Ribbon Changing procedure to load the ribbon.
7. Close the cover.

8. Place the printer where you desire to use it.
9. Remove the data cable from the pouch in which it was shipped. *SAVE* the pouch for future use.
10. Connect the data cable to the printer. This procedure is explained later in this section. Figure 3-1 shows the receptacle for the data cable.

WARNING

You must follow the Data Cable Connecting procedure carefully to ensure that a correct connection is made. An incorrect connection could damage the equipment.

11. Plug in the Power Cord. See Figure 3-1. The printer is now ready for use.

Packing the Unit

1. Disconnect the Data Cable and the Power Cord.
2. Open the printer cover and remove the ribbon cartridge.
3. Pack the ribbon cartridge in a clean envelope or some other protective device.
4. Take the protective material that you have saved and pack this material carefully around the internal mechanics.

Note: Ensure that the printhead is tied down and not capable of any movement.

5. Close and secure the cover to the base of the printer by using either a piece of masking tape or a strong elastic.
6. Carefully place the printer into the box in which it was shipped.
7. Put the data cable into the pouch in which it came.
8. Put the data cable and pouch into the printer box.
9. Seal the box with tape. The printer is ready for shipment.

Host-Printer Connection

The host-printer connection may be either direct connect or via a modem interface. Figure B-1 shows these connections.

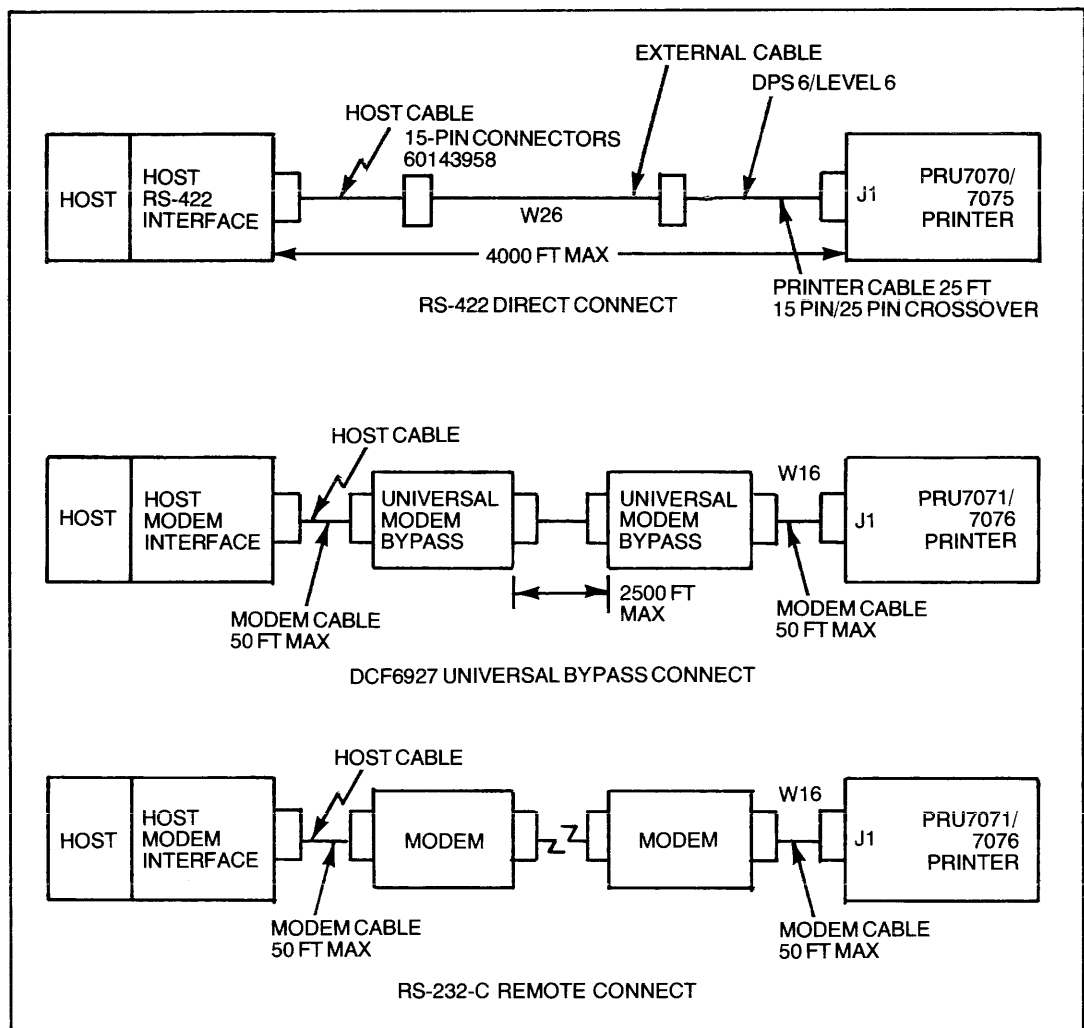

Figure B-1. Host-Printer Connection

Direct Connection

Direct connection can be accomplished in two ways:

- RS-422-A balanced direct
- Universal modem bypass

The RS-232-C direct connect enables local communications up to a distance of 50 feet. The RS-422-A balanced direct connect enables local communication up to 4000 feet at data rates up to 19,200 bits per second.

The universal modem bypass (DCF6927) is a self-contained, stand-alone device enabling local communications over a distance of up to 2500 feet over ordinary telephone cable. It is designed as an inexpensive replacement for a modem over this limited distance.

Modem Interface Connection

Connection via a modem interface enables maximum flexibility in host-printer communications via the use of full-duplex data sets. Data rates can be run up to 1200 baud for types to be used (see Table B-1).

Table B-1. Bell System Asynchronous Data Sets

Type	Maximum Data Rate	Line Type	Wire
103A	300	S/P	2W
103F	300	P	2W
103J	300	S	2W
113A	300	S	2W
212A	300/1200	S	2W

P — indicates Private Nonswitched
S — indicates Switched
2W — indicates Two Wire

Data Cable Connecting Procedure

Cable connection involves plugging a cable connector into the appropriate receptacle just as you would plug a cord into a wall outlet. You should remember to press gently when plugging the connector into its receptacle so that you will avoid bending the pins in the connector.

If your printer is intentionally or accidentally moved and the data cable becomes disconnected from the printer, you can easily connect the data cable to the printer by performing the following procedure. There are two different cables made for these printers, depending on which model you have.

Cable Connection for the PRU7070/7075 Printers

There is a 25-pin connector attached to the end of the cable that connects to the printer and a 15-pin connector attached to the other end of the cable that connects to the host.

1. Take the end of the cable with the 25-pin connector and connect it to the printer. Figure 3-1 shows the receptacle where the cable connector should be inserted.

2. Secure the connector to the printer by tightening the two screws on the connector.

Cable Connection for the PRU7071/7076 Printers

There are two 25-pin connectors attached to the cable, one at each end.

1. Take one end of the cable and connect it to the printer. Figure 3-1 shows the receptacle where the cable connector should be inserted.
2. Secure the connector to the printer by tightening the two screws on the connector.

Positioning the Jumpers

When you first unpack your printer and are preparing it for use, open the cover and look at the printer circuit board (see Figure B-2). Located to the right of the internal switches will be two small blue plastic objects called “jumpers” (Figure B-3) that will be covering two sets of three gold pins (Figure B-4). Correct positioning of these blue jumpers is necessary to ensure proper operation of the printer.

There are two different positions for each jumper and set of pins, depending on the printer model that you purchased. The top set of pins determines either the RS-232-C or the RS-422-A interface. The bottom set of pins determines printer selection: either the PRU7070/7071 or the PRU7075/7076.

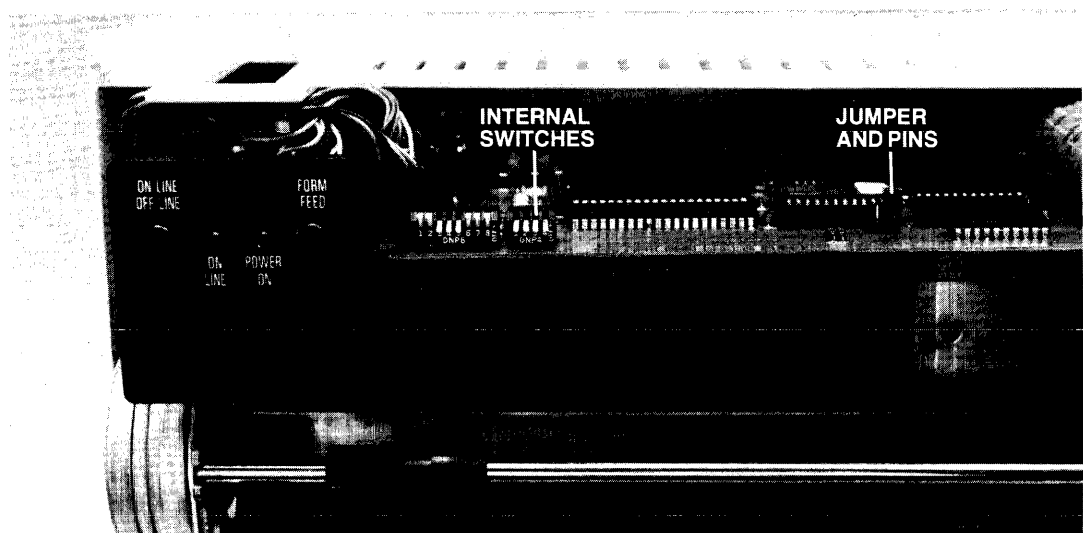

Figure B-2. Jumper and Pins

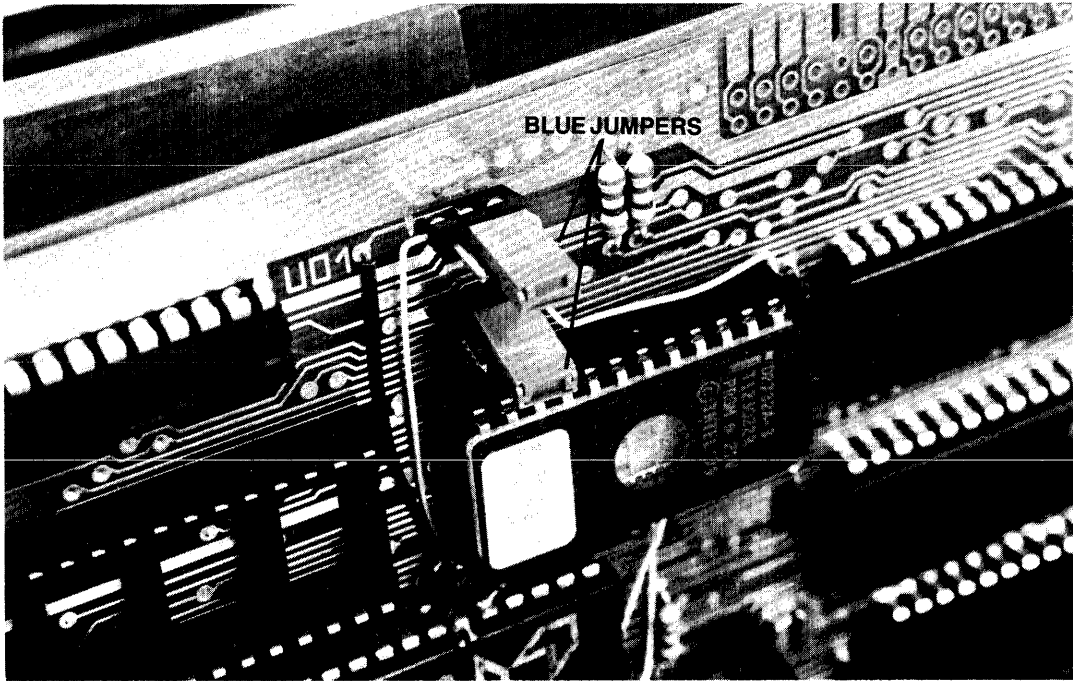

Figure B-3. Blue Jumpers Covering Two Sets of Gold Pins

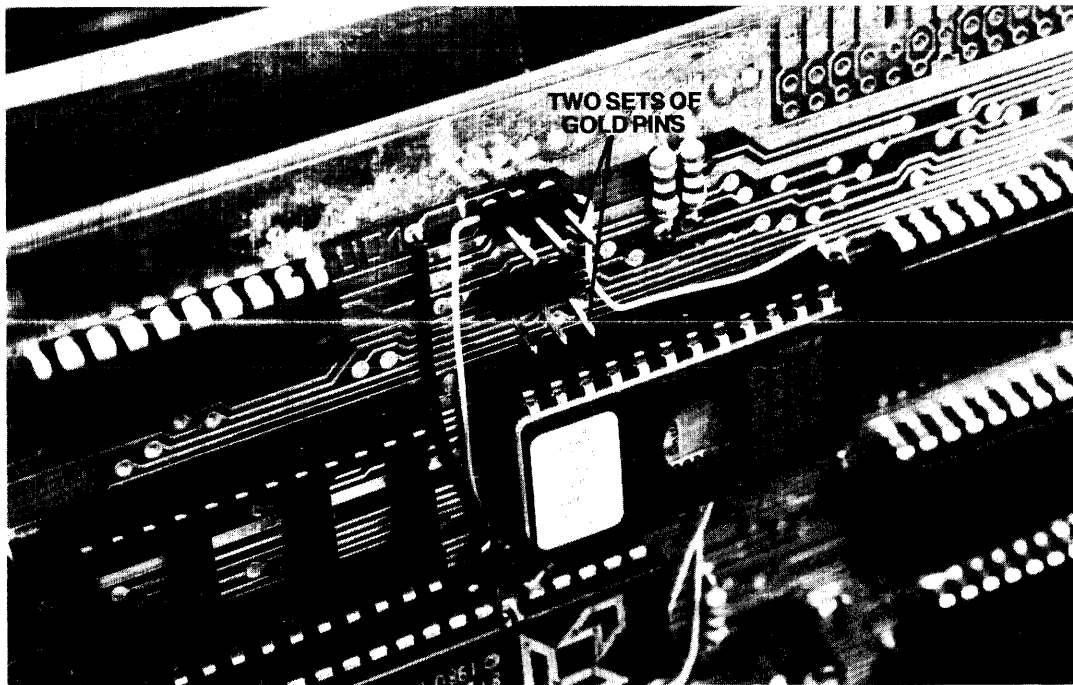

Figure B-4. Two Sets of Gold Pins

Jumper Positions for the TOP Set of Gold Pins

The PRU7071/7076 (RS-232-C interface) is selected when the blue jumper is covering pins 3 and 2 (see Figure B-5).

The PRU7070/7075 (RS-422-A interface) is selected when the blue jumper is covering pins 2 and 1 (see Figure B-5).

Jumper Positions for the BOTTOM Set of Gold Pins

The PRU7070/7071 (10-inch carriage) is selected when the blue jumper is covering pins 2 and 1 (see Figure B-5).

The PRU7075/7076 (15-inch carriage) is selected when the blue jumper is covering pins 3 and 2 (see Figure B-5).

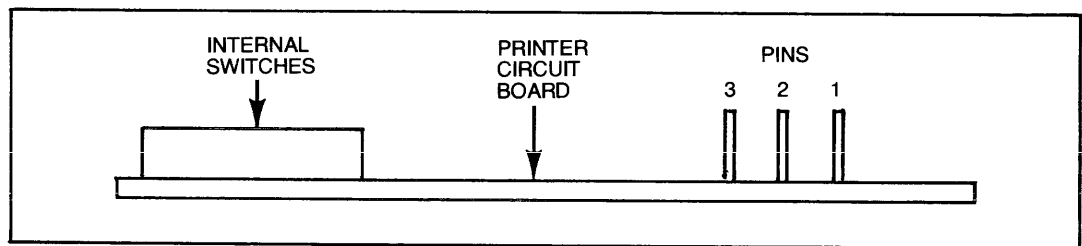

Figure B-5. Graphic Representation of 3 Gold Pins on the Printer Circuit Board

Appendix C

Specifications

Printing Method: Impact, character-by-character, one line at a time, bidirectionally with logic-seeking

Character Structure: 9 × 7 dot matrix (vertical × horizontal)

Character Set: 96 ASCII uppercase and lowercase characters plus 11 line graphics

Character Size: 0.133 in. × 0.073 in. (0.338 cm × 0.187 cm) vertical × horizontal (normal)

Pitch:

Vertical 6 and 8 lines per inch

Horizontal 5, 8.3, 10, and 16.7 characters per inch

Inking Method: Interchangeable ribbon cartridge, Honeywell No. M3917

Paper Transport: Pull-sprocket

Paper: Sprocket-feed, continuous fanfold 3.0 in. to 10.0 in. (7.6 cm to 25.4 cm) wide for the PRU7070/7071 and 3.0 in. to 15.0 in. (7.6 cm to 38.1 cm) wide for the PRU7075/7076; 0.012-in. (0.03-cm) maximum thickness; original and up to two copies

Forms Length: 3.5; 4; 5.5; 7; 8.5; 11; 12; or 14 in.; switch-selectable; 1 to 94 lines program-selectable (program overrides switch selection)

Line Spacing: 6 or 8 lines per inch; switch-selectable with program override.

Data Rate: 300, 1200, or 9600 bits per second (switch-selectable)

Operator Controls: Power on/off; online/offline; form feed

Indicator Lights:

Power On — ac and dc power present

On Line — Steady glow indicates logical connection to the host controller; blinking means fault detected or paper out

Cables:

Data Cable — 25 ft (7.6 m) standard: VCW2624 for PRU7070/7075 and VCW1604 for PRU7071/7076

Power Cable — 6.5 ft (2.0 m)

Physical Characteristics (PRU7070/7071):

Height — 6.9 in. (17.5 cm)
Width — 16.3 in. (41.5 cm)
Depth — 13.0 in. (33.0 cm)
Weight — 20.5 lb (9.5 kg)

(PRU7075/7076):

Height — 6.9 in. (17.5 cm)
Width — 20.8 in. (52.2 cm)
Depth — 13.0 in. (33.0 cm)
Weight — 27.5 lb (12.5 kg)

Electrical Characteristics:

Voltage — 120 Vac + 10%, -15% @ 60 Hz ±0.5 Hz
Current — 0.8A @ 120 Vac
Input Power — 96 W (maximum)

Environmental Characteristics:

Temperature — +50°F to +100°F (+10°C to +38°C) (operating)
Relative Humidity — 10% to 90% noncondensing (operating)

Table C-1. Print Characteristics

	Normal Character (Single-Width)		Elongated Character (Double-Width)	
	Normal Pitch	Compressed Pitch	Normal Pitch	Compressed Pitch
Characters per inch	10	16.7	5	8.3
Characters per line				
(PRU7070/7071)	80	132	40	66
(PRU7075/7076)	132	220 (left justified)	66	110 (left justified)
Print speed (Characters per second)	100	100	50	50

Table C-2. Media Specifications

Media	Weight		Forms Width	
	Grams per Square Meter	Pounds per 500 Sheets	PRU7070/7071	PRU7075/7076
1 Original Sprocket Fanfold Form	Min. 55 Max. 80	Min. 15 Max. 20	3 in. (7.62 cm) to 10 in. (25.4 cm) edge to edge	3 in. (7.62 cm) to 15 in. (38.1 cm) edge to edge
1 Original plus 2 Copies Sprocket Fanfold Form (carbon not included)	Min. 45 Max. 75	Min. 12 Max. 20		
Carbon	Max. 35	Max. 9.5		

Cartridge Ribbon: Honeywell No. M3917

Note: Care should be taken when selecting forms with edge bursting because of the type of paper drive sprocket in the printers. Forms with low burst strength could result in difficulty in forms handling.

Honeywell recommends that you purchase media according to the specifications in Table C-2. If media other than the above are used, Honeywell is not responsible for proper operation.

Appendix D

ASCII Character Set and Command Sort List

Table D-1 shows the ASCII Character Set for the printers.

Table D-1. PRU7070/7071 and PRU7075/7076 ASCII Character Set

b_7 _____ b_6 _____ b_5 _____					0	0	0	0	1	1	1	1
					0	0	1	1	0	0	1	1
					0	1	0	1	0	1	0	1
b_4	b_3	b_2	b_1	COL. ROW I	0	1	2	3	4	5	6	7
0	0	0	0	0		DLE	(2)	0	@	P	\	p
0	0	0	1	1			!	1	A	Q	a	q
0	0	1	0	2	STX		"	2	B	R	b	r
0	0	1	1	3	ETX		#	3	C	S	c	s
0	1	0	0	4	EOT	DC4	S	4	D	T	d	t
0	1	0	1	5	ENQ		%	5	E	U	e	u
0	1	1	0	6	ACK		&	6	F	V	f	v
0	1	1	1	7			'	7	G	W	g	w
1	0	0	0	8			(8	H	X	h	x
1	0	0	1	9)	9	I	Y	i	y
1	0	1	0	A	LF		*	:	J	Z	j	z
1	0	1	1	B		ESC	+	;	K	[k	{
1	1	0	0	C	FF		,	<	L	\	l	
1	1	0	1	D	CR		-	=	M]	m	}
1	1	1	0	E			.	>	N	^	n	~
1	1	1	1	F			/	?	O	-	o	DEL(1)
96 Printable ASCII Characters												

- Notes: 1. DEL code (hex: 7F) is completely ignored
 2. This code prints a space

Table D-2 gives a summary of the printer commands listed alphabetically by mnemonics.

Table D-2. Command Sort List of ASCII, Hexadecimal, Octal, and Mnemonic Assignments (alphabetically listed by mnemonics)

Mnemonic	Command	ASCII	Hexadecimal	Octal
CPS	SET 16.7 CPI PITCH	ESC s 8	1B-73-38	033-163-070
CPT	SET 10 CPI PITCH	ESC s 5	1B-73-35	033-163-065
CR	CARRIAGE RETURN	CR	0D	015
CUS	SET UNDERLINE	ESC s _	1B-73-5F	033-163-137
DWC	SET DOUBLE WIDTH	ESC s 2	1B-73-32	033-163-062
FF	FORM FEED	FF	0C	014
FLS	SET FORM LENGTH	ESC "SPACE" "XY"	1B-20-"XY"	033-040-"XY"
LDE	SET 8 LPI	ESC u	1B-75	033-165
LDS	SET 6 LPI	ESC U	1B-55	033-125
LF	LINE FEED	LF	0A	012
LGR	LINE GRAPHICS RESET	ESC F	1B-46	033-106
LGS	LINE GRAPHICS SET	ESC G	1B-47	033-107
RSR	RESTORE	ESC s R	1B-73-52	033-163-122
		ESC s r	1B-73-72	033-163-162

HONEYWELL INFORMATION SYSTEMS
Technical Publications Remarks Form

CUT ALONG LINE

TITLE

PRU7070/7071 & PRU7075/7076
PRINTERS HANDBOOK

ORDER NO.

CY93-01

DATED

DECEMBER 1982

ERRORS IN PUBLICATION

[Empty box for reporting errors in publication]

SUGGESTIONS FOR IMPROVEMENT TO PUBLICATION

[Empty box for providing suggestions for improvement to publication]



Your comments will be investigated by appropriate technical personnel and action will be taken as required. Receipt of all forms will be acknowledged; however, if you require a detailed reply, check here.

FROM: NAME _____

DATE _____

TITLE _____

COMPANY _____

ADDRESS _____

PLEASE FOLD AND TAPE—
NOTE: U. S. Postal Service will not deliver stapled forms



NO POSTAGE
NECESSARY
IF MAILED
IN THE
UNITED STATES

BUSINESS REPLY MAIL
FIRST CLASS PERMIT NO. 39531 WALTHAM, MA02154

POSTAGE WILL BE PAID BY ADDRESSEE

HONEYWELL INFORMATION SYSTEMS
200 SMITH STREET
WALTHAM, MA 02154

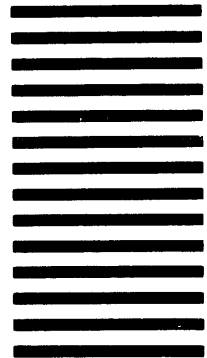

ATTN: PUBLICATIONS, MS486

Honeywell

FOLD ALONG LINE
CUT ALONG

Honeywell

Honeywell Information Systems

In the U.S.A.: 200 Smith Street, MS 486, Waltham, Massachusetts 02154

In Canada: 155 Gordon Baker Road, Willowdale, Ontario M2H 3N7

In the U.K.: Great West Road, Brentford, Middlesex TW8 9DH

In Australia: 124 Walker Street, North Sydney, N.S.W. 2060

in Mexico: Avenida Nuevo Leon 250, Mexico 11, D.F.

35958, 1282, Printed in U.S.A.

CY93-01